

- SMART 3D scanning vibrometry system for full-field vibration measurements
- Intuitive, integrated and seamless software
- Intelligent 3D-calibration and intuitive usability
- Compact design with 7-inch touch display
- Synchronization with other SMART devices
- Built-in data acquisition and signal generation
- Flexible measurement setups: 3D scanning system or three independent scanning vibrometers

SMART 3D-SCAN

Intuitive 3D full-field vibration analysis: The SMART 3D Scan enables real-world vibration analysis of any test object, either in 3D or from all sides with convenient access to all data for a seamless user-experience.

General specifications

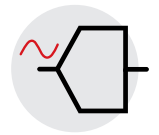

3D scanning system specifications

3 fully-featured scanning vibrometers, each with a 4K camera, multiple reference inputs, and signal generator functionality
Truly compact 3D vibration analysis system which requires no additional data acquisition, signal generator or signal processing hardware.
All required cables for 3D scanning measurements, user-replaceable and locally available
Single broadband ethernet connection to a PC running our versatile scanning software, SMART Lab
SMART Lab can be installed on any modern PC with Windows 10 or higher. Simply upgrade your PC if you require more power
Each scanning vibrometer can be operated independently in 360° full-body scanning mode
The 3D scanning system can later be extended to a full-body laser Doppler vibrometry system by adding additional scanning vibrometer
High-quality tripod set for simple setup of the 3D scanning system in a variety of different conditions
Truly portable: the entire 3D scanning system can be packed into three compact transport cases for the vibrometers and three bags for the tripods
Fully digital signal path from DC to 8 MHz - no limitations that depend on the measured signal frequencies
Highly accurate synchronization for the best results under all circumstances

Overview

Measured quantities	Velocity, displacement, acceleration
Max. frequency bandwidth	DC to 50 MHz
Frequency range	Can be chosen individually using a freely configurable band-pass filter for velocity, displacement and acceleration signal
Max. velocity	50 m/s
Measurement ranges	Measurement range limits can be freely adjusted between <ul style="list-style-type: none">• 1 mm/s and 50 m/s for velocity• 10 nm and 100 m for displacement• 10 m/s² and 100 Mio. m/s² for acceleration
Signal processing	Digital (FPGA based)
Filter	Low-pass and high-pass filters are defined by the selected frequency range Tracking filter: off / slow / fast
User interface	7" Full HD+ touchscreen with 1000 nits peak brightness
Operating Temperature	0 °C to 40 °C
Dimensions	Length × width × height (excluding handle): 365 × 194 × 196 mm

Weight	~ 7.8 kg
Power Supply	100 - 240 V AC (50-60 Hz) or 12 V DC
Portability	Convenient all-in-one design for seamless portability and simple setup
Storage temperature	-10 °C to 65 °C
Relative humidity	Max. 80 %, non-condensing
Calibration interval	Every 24 months (recommended)

The exact features depend on the configured options.

Measurement specifications

Scan angle	50° x 40°, resolution below 0.001°, stability better than 0.001°/h
Max. scan points per second	30
Scan point density	Up to 512 x 512 scan points
Camera	<ul style="list-style-type: none"> • 4 K 2160p, 40 x hybrid zoom (1080p equivalent), 20 x optical zoom • Horizontal viewing angle: 63.7° (wide end) to 3.2°, driverless installation
Geometry unit	Measure distances to objects and their geometry
Sample size	Min. < 1 mm ² , max. > 10 m ²

Inputs and Outputs

Analog signal inputs	<ul style="list-style-type: none"> • Up to 12 channel Lemo, ± 1 V / ± 10 V, for synchronous reference signal recording • 24-bit A/D converter per channel • Support for IEPE (Integrated Electronic Piezoelectric), TEDS and DC/AC coupling • Input impedance 1 MOhm 20 pF (other configurations up to 1 GOhm 3 pF available on request)
Analog HF signal inputs	<ul style="list-style-type: none"> • Up to 3 channel (BNC), ± 1 V synchronous high-frequency (HF) signal recording • Input impedance 50 Ohm
Analog signal outputs	<ul style="list-style-type: none"> • Up to 8 x BNC, ± 2 V • Versatile signal outputs: Analog velocity, displacement, acceleration and arbitrary signal generator • Produce various preset functions (sine, chirp, gaussian, ...) or load arbitrary signals • Configure up to 8 independent signal generator channels • Data rate: 312.5 Msamples/s @ 16 bit • Source impedance 50 Ohm
Digital signal output & PC-Interface	<ul style="list-style-type: none"> • 10 Gbit RJ45 Ethernet: Data rate: 10 Gbit/s (up to 312.5 MSamples/s @ 48 bit) • Digital data acquisition- and analysis software SMART Lab • Digital remote control of device settings
External trigger	<ul style="list-style-type: none"> • Digital external trigger in/out via SMB • Configurable with up to 3 x digital trigger inputs and 3x digital trigger outputs

The exact features depend on the configured options.

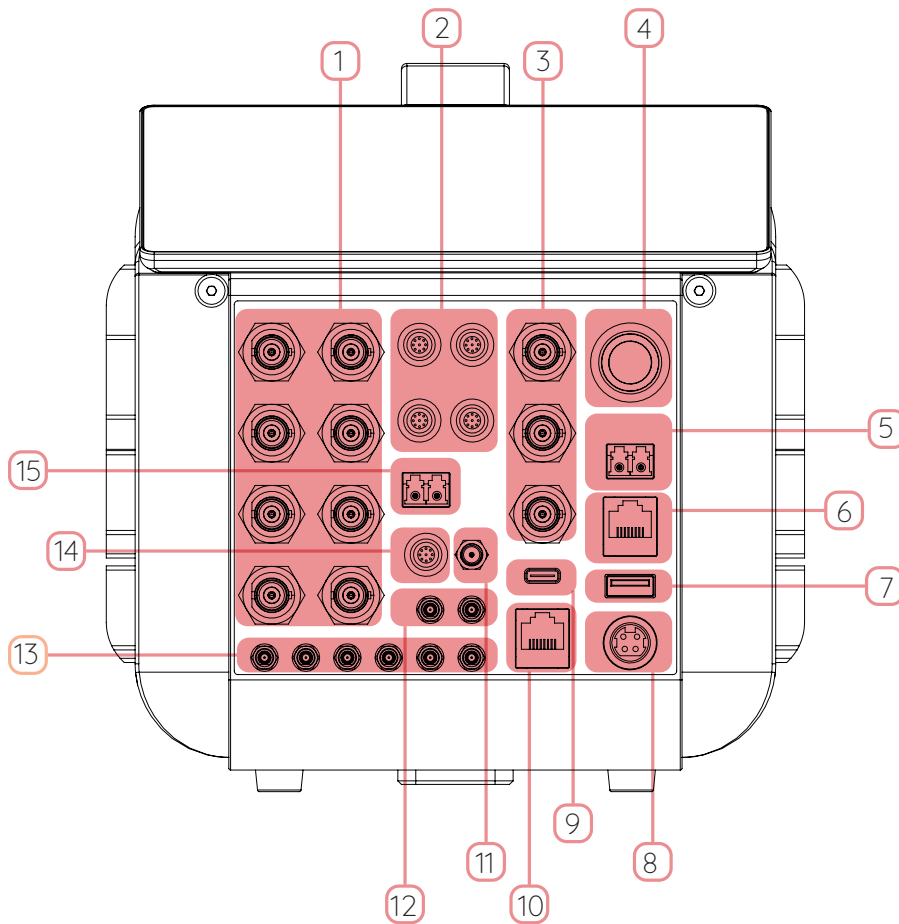

1	Analog signal outputs (BNC)	9	USB port (Type-C)
2	LEMO signal inputs (12 channels)	10	Ethernet port: for device communication/data
3	BNC HF signal inputs (up to 50 MHz)	11	GNSS antenna connector
4	Power button	12	10 MHz SMB ports
5	Optical communication port	13	Multi-purpose SMB ports
6	Ethernet port: for device communication/data	14	Power output
7	USB port (Type-A)	15	Optical fiber connector (LC-Duplex)
8	Power input		

Configurable options



Connectivity

Analog IN	12	Lemo, $\pm 1\text{ V} / \pm 10\text{ V}$	Synchronous recording of reference signals with 24 bits precision and up to 1.5 MSPS. DC/AC coupling
HF Analog IN	3	BNC, $\pm 1\text{ V}$	Synchronously record reference signals up to 50 MHz with 14 bits precision and ultra-high sample rates of 312.5 MSPS
Analog OUT	8	BNC, $\pm 2\text{ V}$	Velocity, displacement, acceleration and signal generator output with 16 bits precision and up to 312.5 MSPS
Digital IN	2	SMB	Enables external triggering of the device or PPS
Digital OUT	2	SMB	Trigger external devices or use as PPS
Digital interface	3	<ul style="list-style-type: none"> • 10 Gbit/s ethernet • 1 Gbit/s ethernet • Fiber optical or copper 	<ul style="list-style-type: none"> • Stream the measurement data over ethernet with up to 312.5 MSPS and control the vibrometer remotely • Use the vibrometer as a control hub for your ethernet-based equipment • Synchronize the vibrometer with other SMART series devices
USB (optional)	2	<ul style="list-style-type: none"> • 1 x USB-C (USB 3.2) • 1 x USB-A (USB 3.0) 	Connect USB devices such as cameras, keyboards or storage devices to the vibrometer for direct data recording
Bluetooth (optional)			Connect human interface devices such as keyboard, mouse or headphones to the vibrometer
Wi-Fi (optional)			Control your vibrometer wirelessly and stream measurement data over the air using the fast Wi-Fi 7 connection
Inertial measurement unit (IMU) (optional)			Record acceleration and orientation of the device for more accurate alignment with your test object and monitoring of vibrations of the vibrometer itself
GNSS module (optional)			GNSS module for precise absolute time and position
Synchronization (optional)	2	SMB	10 MHz output and 10 MHz input for synchronization with other devices + 1 x PPS output and 1 x PPS input

The exact features depend on the configured options.

Frequency options

Basis	Measure frequencies up to 250 kHz, covering the entire acoustic range and beyond	S
High frequency	Measure frequencies up to 5 MHz	O
Master	Measure frequencies up to 10 MHz	O
Ultra	Measure frequencies up to 25 MHz	O
Elite	Measure frequencies up to 50 MHz to the limit of what is technologically feasible	O

Frequency upgrade M	Upgrade the frequency limitation of any option by 500 kHz	<input type="radio"/>
Frequency upgrade L	Upgrade the frequency limitation of any option by 1 MHz	<input type="radio"/>
Frequency upgrade XL	Upgrade the frequency limitation of any option by 5 MHz	<input type="radio"/>

Velocity options









Basis	Continuously adjust the velocity measurement range between 10 mm/s and 15 m/s	<input checked="" type="radio"/>
High Speed	Measure velocities up to 25 m/s	<input type="radio"/>
Master	Measure velocities up to 50 m/s	<input type="radio"/>
Ultra	Measure velocities up to 50 m/s and get access to the high resolution upgrade with the smallest velocity measurement range of 1 mm/s	<input type="radio"/>
High resolution upgrade	Smallest velocity measurement range 1 mm/s	<input type="radio"/>
Velocity upgrade M	Increase the maximum velocity of any velocity option by 2.5 m/s	<input type="radio"/>

Measurement quantities

Velocity	Measure vibrational velocities	<input checked="" type="radio"/>
Displacement	Measure vibrational displacements with continuously adjustable ranges from 10 nm to 100 m	<input type="radio"/>
Acceleration	Measure vibrational accelerations with continuously adjustable ranges from 10 m/s ² to 100 Mio. m/s ²	<input type="radio"/>

Maintenance

Warranty	12 months	<input checked="" type="radio"/>
Warranty extension	Extension of standard warranty to 24 months	<input type="radio"/>
Extended maintenance	Additional extension of hardware maintenance by 12+ months	<input type="radio"/>
Recalibration & cleaning	Check, cleaning & realignment of optical parts, check of laser output power, and factory calibration	<input type="radio"/>

Transport case	<ul style="list-style-type: none"> • Stable and waterproof Peli case for safe storage and transport of vibrometer • External dimensions (L x W x H): 62.5 x 49 x 35 cm 	S	
Close-up unit	For measurements of small objects with stand-off distances in the range of millimeters	O	
Protection window	Protects the scanning unit against dust, wind, and acoustic excitation at high sound pressure levels	S	
Transport bag	Compact and light transport bag for outdoor measurements	O	
Coaxial unit	Aligns the optical axes of measurement laser and camera	O	
Tripod with fluid head	Precisely align your vibrometer with high-quality tripods by Manfrotto	O	
Ring light	For illumination of small test objects. Requires Close-up Unit.	O	
Mirror set	Enables contactless vibration measurements even where access is difficult. The mirror set contains 4 front surface mirrors.	O	
IR-detector card	Transforming the invisible infrared light into a spot of visible light	S	

Optical specifications



Overview

Working distances	<ul style="list-style-type: none"> • Variable working distance from 250 mm to 100 m • With Coaxial Unit: 111 mm to 1 m • With Close-Up Unit: below 6.5 mm to 54 mm
Laser wavelength	Measurement laser: 1550 nm, Target laser: 510-530 nm
Laser safety class	<ul style="list-style-type: none"> • Measurement laser: output power: <10 mW, class 1 • Target laser: output power: <1 mW, class 2
Lens	Long-Range, 100 mm focal length
Optics	Auto-, and manual focusing

Spot size and depth of focus

Stand-off distance	Spot diameter (1/e ² , typical)	Depth of focus (typical)
mm	µm	± mm
250	65	2
500	89	4
1000	141	10
1500	190	18
2000	242	30
2500	293	44
5000	530	142
Every additional meter	+ 94	

Spot size and depth of focus with optional close-up unit

Stand-off distance	Spot diameter (1/e ² , typical)	Depth of focus (typical)
mm	µm	± mm
54	13	0.1
50	14	0.1
45	14	0.1
40	15	0.1
35	16	0.1
30	18	0.2
25	20	0.2
20	22	0.2
15	23	0.3
10.6	25	0.3
6.5	26	0.3



DO NOT STARE INTO BEAM Class 2 Laser Product

Laser CLASS 1: invisible, $\lambda = 1550$ nm, output power: < 10 mW

Laser CLASS 2: visible, green laser, $\lambda = 510-530$ nm, output power: < 1 mW

Software



SMART Lab software features

Remote control	<ul style="list-style-type: none"> All vibrometer settings via a single ethernet connection Measurement and target laser: spatial position, autofocus, brightness Zoom, focus and color options of 4K video camera Multiple vibrometers at once for reference, multipoint and 3D vibration measurements
Measurement setup	<ul style="list-style-type: none"> Live 4K video feed of all connected vibrometers Automatic or manual calibration of laser movement with camera image Freely choose measurement geometry and individual point positions using different options- <ul style="list-style-type: none"> Shape-based: Choose from a variety of different shapes (rectangles, circles and polygons) and mesh grid options (rectangular, radial, triangular) for fast and simple definition of the measurement points Point-based: Define measurement points inside or outside of the existing grid or place and manipulate points freely Geometry-based: Select measurement areas based on the loaded 3D models and automatically generate mesh points Check the calibration of the laser beam at any time, including mathematical error computations
Data acquisition	<ul style="list-style-type: none"> Phase correct acquisition of vibrometer signal and reference channels Convenient access to all your data in a single software - from vibrometers to multiple reference sensors Triggering on measured signals or external triggers Seamless switching between time and frequency-domain representation Frequency domain representation with up to 536 Mio FFT lines Multi-channel arbitrary signal generator to generate predefined signals (sine, sine sweep, rectangle, random, etc.) or custom signals from imported .csv or .wav files Various averaging options, including smart averaging taking only blocks with good signal quality into account Several window functions for FFT calculations, including rectangular, hanning, hamming, exponential Real-time signal analysis and improvement based on speckle tracking and smart averaging
Measurement analysis	<ul style="list-style-type: none"> Calculation of various frequency functions: FRF, FFT, Auto-Spectrum, Cross-Spectrum, Coherence Presentation of frequency-domain results in magnitude and phase 3D-animation of mode shapes at user-defined frequencies based on FRF and FFT data Entirely customizable view options including color maps, viewing angles, texture surfaces, etc. 2D heatmaps of FRF magnitude and phase, FFT magnitude, time data RMS, and coherence
Data import and export	<ul style="list-style-type: none"> Multithreaded export of ODS data, time data, geometry data, all frequency functions, and data of reference channels to Universal File Format (.uff), to Hierarchical Data Format (.hdf5) and to MATLAB® file format (.mat) Export time data as .wav audio file Export animations of time data (wave-propagation) and selected mode-shapes as high resolution (up to 4K) video file Take screenshots from within our software and export with up to 4K resolution Import geometry data as STL file Save projects to and load projects from the native file format

SMART Lab runs on any modern computer with Microsoft Windows.

SMART Lab software options

Geometry unit to measure the 3-dimensional geometry of your object and the absolute distance to the vibrometer	<input type="radio"/>
Time domain analysis and animation to visualize the propagation of vibrations	<input type="radio"/>
Modal analysis to gain insight in the dynamical properties of the device under test	<input type="radio"/>
Basic software maintenance: 2 years of included software updates	<input type="checkbox"/>
Extended software maintenance: 2 more years of software updates	<input type="radio"/>

Mechanical parameters

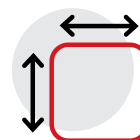

Overview

Dimensions	Length x width x height (excluding handle): 365 x 194 x 196 mm
Weight	~ 7.8 kg
Operating Temperature	0 °C to 40 °C
Storage Temperature	-10 °C to 65 °C
Relative Humidity	max. 80 %, non-condensing

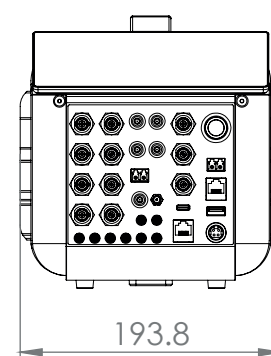
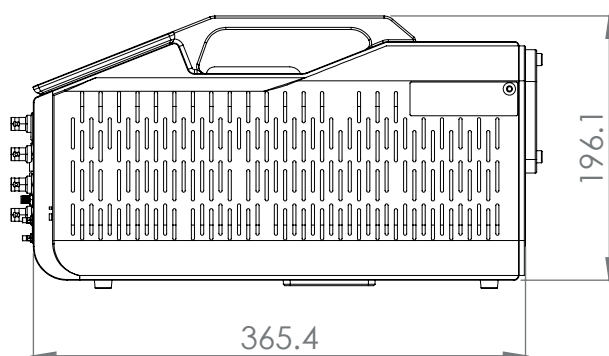
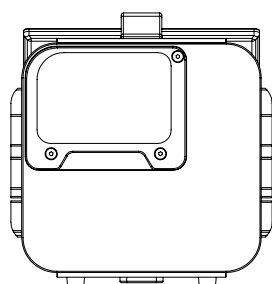
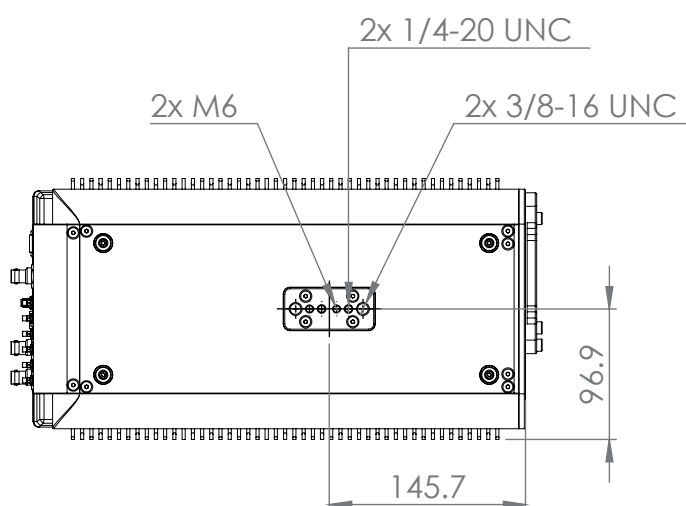

Optomet GmbH
Pfungstaedter Strasse 92
64297 Darmstadt
Germany

Tel.: +49 6151 38432-0
Fax: +49 6151 3688460

sales@optomet.de
<https://www.optomet.com>

optomet.
LASER VIBROMETRY